



# 140×140×51 mm

San Ace 140L 9LG type

## General Specifications

- Material ..... Frame: Aluminum (Black coating), Impeller: Plastic (Flammability: UL 94V-0)
- Expected life ..... See the table below. (L10 life: 90% survival rate for continuous operation in free air at 60°C, rated voltage)
- Motor protection function ..... Locked rotor burnout protection, Reverse polarity protection  
For details, please refer to p. 529.
- Dielectric strength ..... 50/60 Hz, 500 VAC, for 1 minute (between lead wire conductors and frame)
- Insulation resistance ..... 10 MΩ or more with a 500 VDC megger (between lead wire conductors and frame)
- Sound pressure level (SPL) ..... At 1 m away from the air inlet
- Storage temperature ..... -30 to +70°C (Non-condensing)
- Lead wire ..... ⊕Red ⊖Black (Sensor) Yellow (Control) Brown
- Mass ..... 790 g

## Specifications

The models listed below **have pulse sensors with PWM control function.**

Model no.	Rated voltage [V]	Operating voltage range [V]	PWM duty cycle* [%]	Rated current [A]	Rated input [W]	Rated speed [min <sup>-1</sup> ]	Max. airflow [m <sup>3</sup> /min] [CFM]	Max. static pressure [Pa] [inchH <sub>2</sub> O]	SPL [dB (A)]	Operating temperature [°C]	Expected life [h]
9LG1412P5G001	12	10.2 to 13.8	100	5.16	62	7500	9.0 318	655 2.63	69	-20 ~ +70	180000/60°C
			20	0.31	3.72	2300	2.75 97	80 0.32	38		
9LG1412P5S001	12	10.2 to 13.8	100	1.83	22	5000	6.0 212	295 1.18	57		
			20	0.31	3.72	2300	2.75 97	80 0.32	38		
9LG1424P5G001	24	20.4 to 27.6	100	2.58	62	7500	9.0 318	655 2.63	69		
			20	0.16	3.84	2300	2.75 97	80 0.32	38		
9LG1424P5S001	24	20.4 to 27.6	100	0.91	22	5000	6.0 212	295 1.18	57		
			20	0.16	3.84	2300	2.75 97	80 0.32	38		
9LG1448P5G001	48	40.8 to 55.2	100	1.29	62	7500	9.0 318	655 2.63	69		
			20	0.12	5.76	2300	2.75 97	80 0.32	38		
9LG1448P5S001	48	40.8 to 55.2	100	0.45	22	5000	6.0 212	295 1.18	57		
			20	0.12	5.76	2300	2.75 97	80 0.32	38		

\* PWM frequency: 25 kHz. Fan does not rotate when PWM duty cycle is 0%.

Other sensor specifications are available as options. Refer to the index (p. 557).

## Airflow - Static Pressure Characteristics / PWM Duty - Speed Characteristics Example

**9LG1412P5G001** With pulse sensor with PWM control function

PWM duty cycle

Operating voltage range

PWM duty - Speed characteristics example

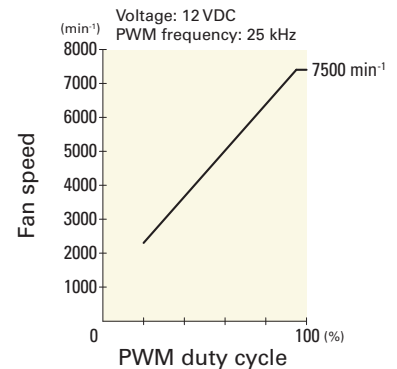
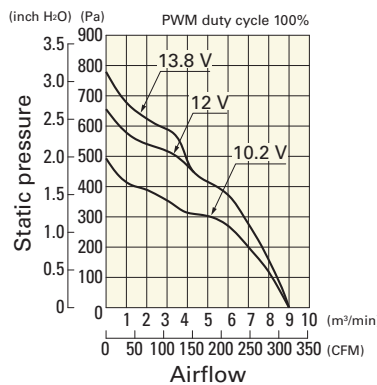
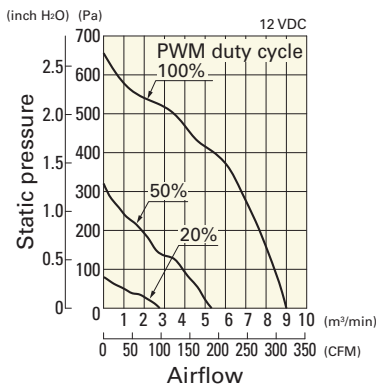

# Airflow - Static Pressure Characteristics / PWM Duty - Speed Characteristics Example

**9LG1412P5S001** With pulse sensor with PWM control function

PWM duty cycle

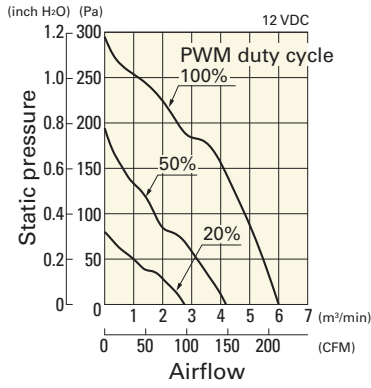

Operating voltage range

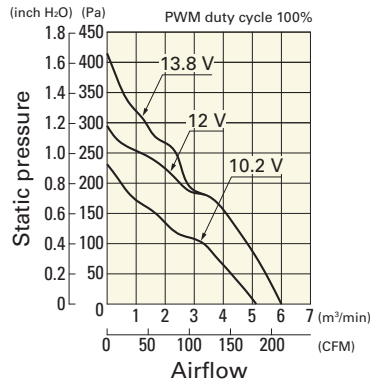

PWM duty - Speed characteristics example

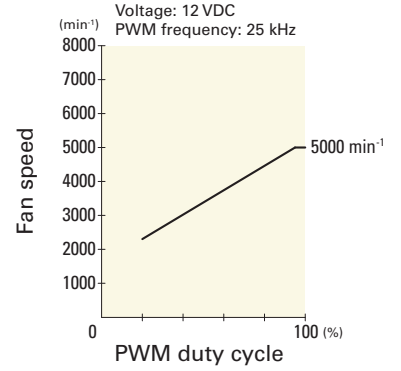

**9LG1424P5G001** With pulse sensor with PWM control function

PWM duty cycle

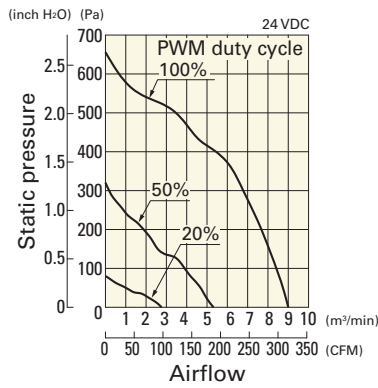

Operating voltage range

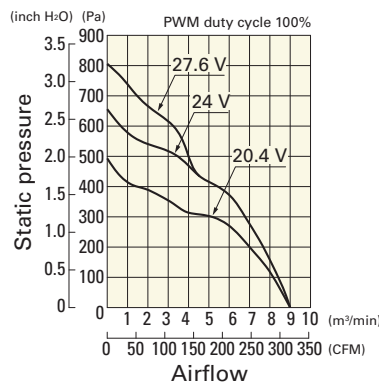

PWM duty - Speed characteristics example

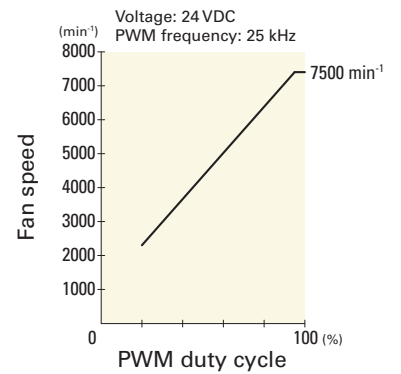

**9LG1424P5S001** With pulse sensor with PWM control function

PWM duty cycle

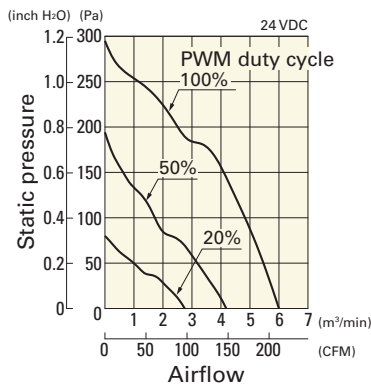

Operating voltage range

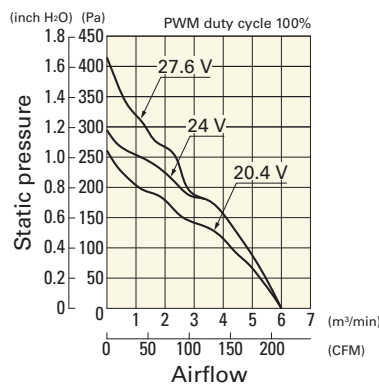

PWM duty - Speed characteristics example

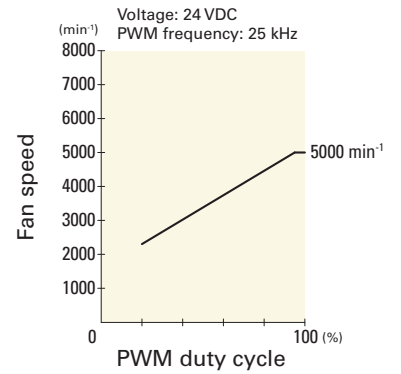

**9LG1448P5G001** With pulse sensor with PWM control function

PWM duty cycle

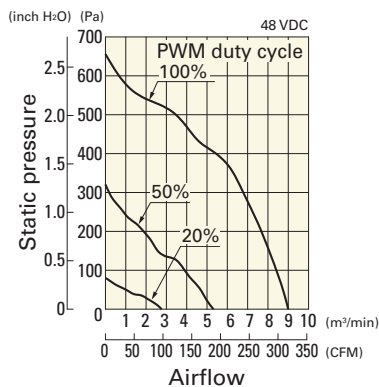

Operating voltage range

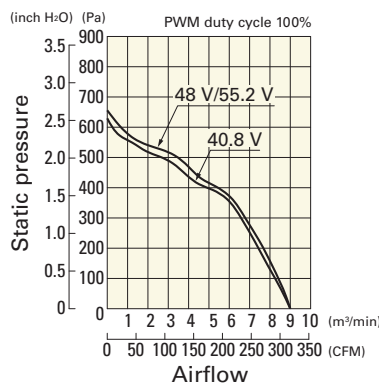

PWM duty - Speed characteristics example

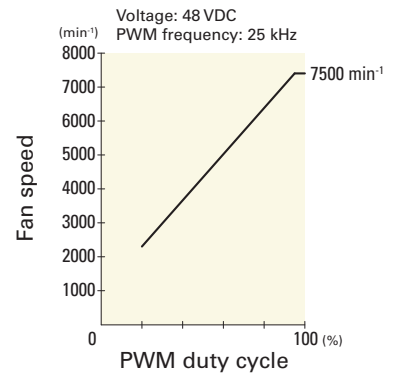

DC

Long Life Fan 140 mm sq.

## Airflow - Static Pressure Characteristics / PWM Duty - Speed Characteristics Example

**9LG1448P5S001** With pulse sensor with PWM control function

PWM duty cycle

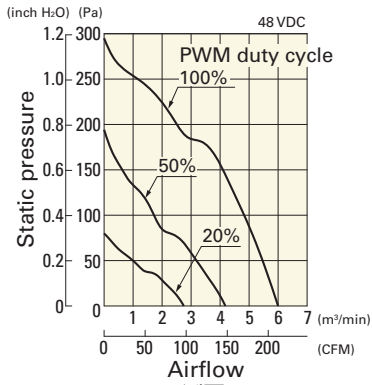

Operating voltage range

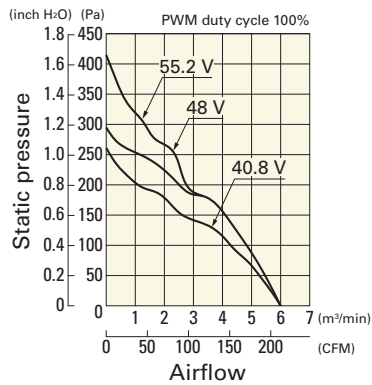

PWM duty - Speed characteristics example

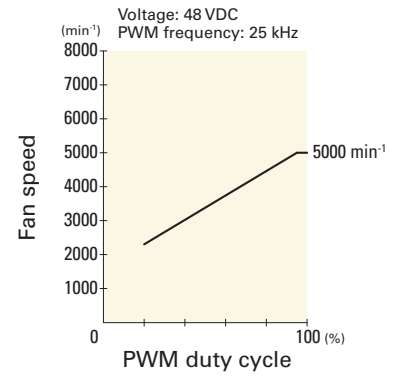

## Dimensions (unit: mm)

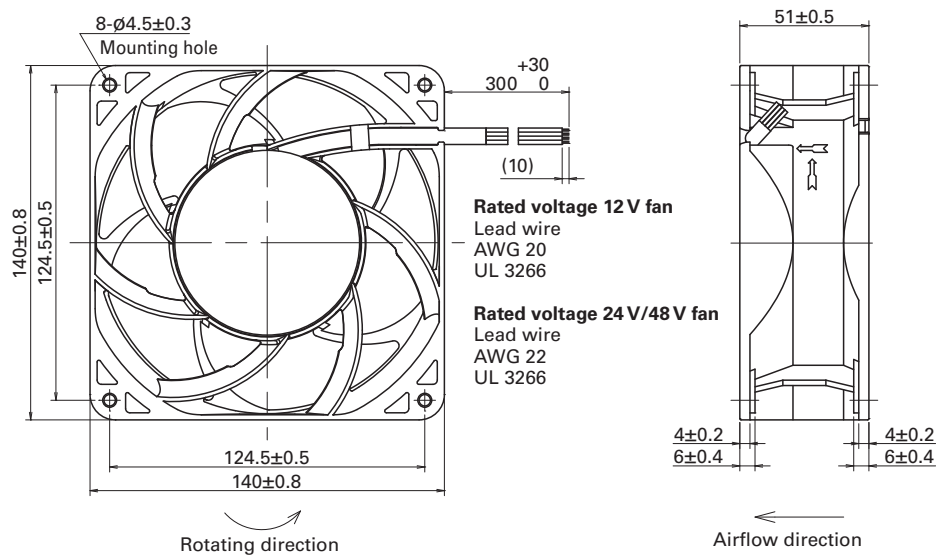

## Reference Dimensions of Mounting Holes and Vent Opening (unit: mm)

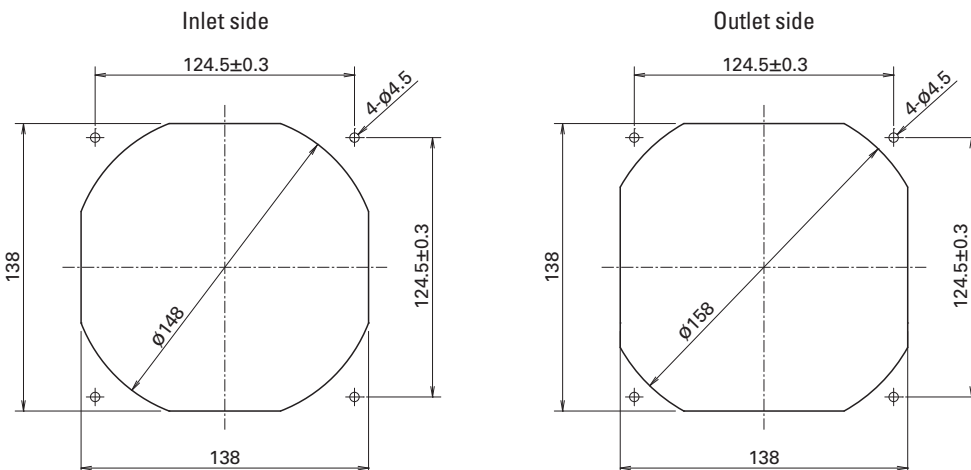

## Options

Finger guards

page: p. 514

Model no.: 109-719, 109-719H