

# 915 MHz Ceramic Chip Antenna

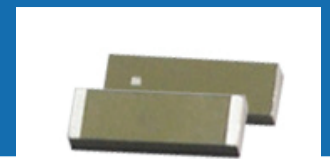

ACAG1204-915-T

12.0 x 4.0 x 1.6mm  
RoHS/RoHS II Compliant  
MSL = 1

## FEATURES

- Uses Low Temperature Co-Fired Ceramic (LTCC) Technology
- Gain of 3.42 dBi
- Omnidirectional
- VSWR of  $\leq 2.0$

## APPLICATIONS

- ISM applications
- LORA
- Sigfox
- RFID

## ELECTRICAL SPECIFICATIONS

Item	Specification
Frequency	915MHz
Bandwidth	15MHz typ
VSWR	$\leq 2.0$
Impedance	50 $\Omega$
Gain	3.42dBi
Azimuth	Omni-directional
Polarization	Linear
Operating Temperature range	-40°C ~+ 85°C

## DIMENSIONS

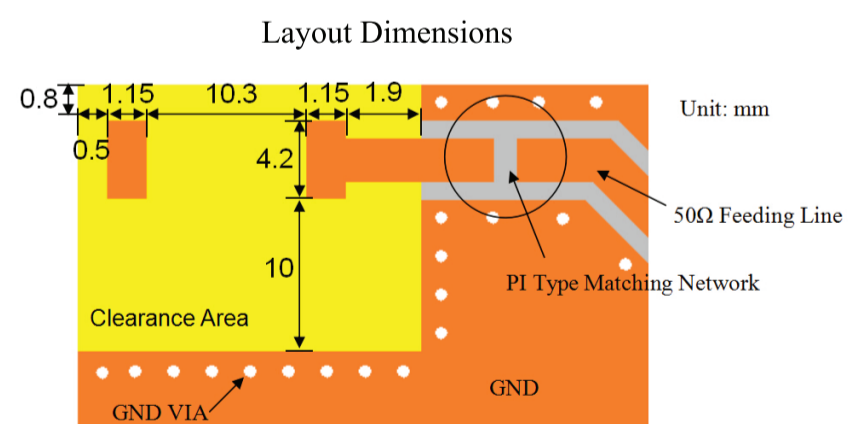
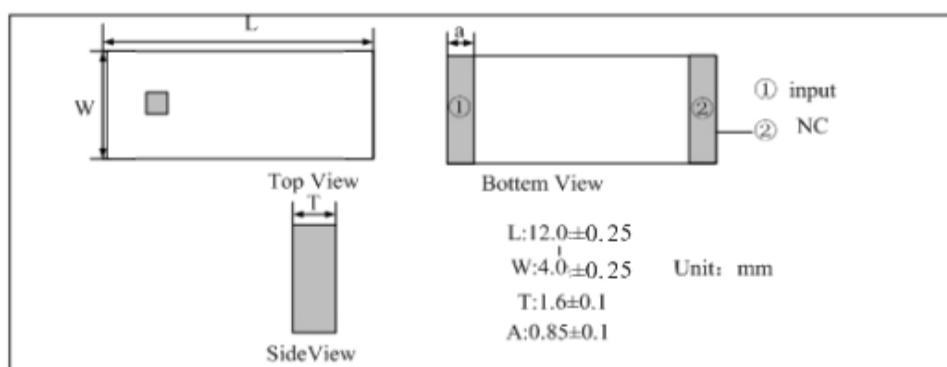

Unit: mm

# 915 MHz Ceramic Chip Antenna

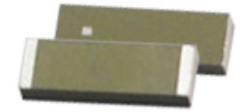

ACAG1204-915-T

12.0 x 4.0 x 1.6mm  
RoHS/RoHS II Compliant  
MSL = 1

## EVALUATION BOARD AND MATCHING CIRCUITS

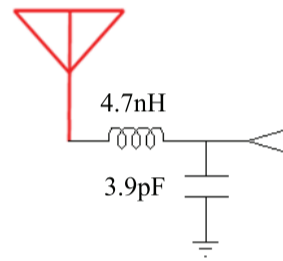
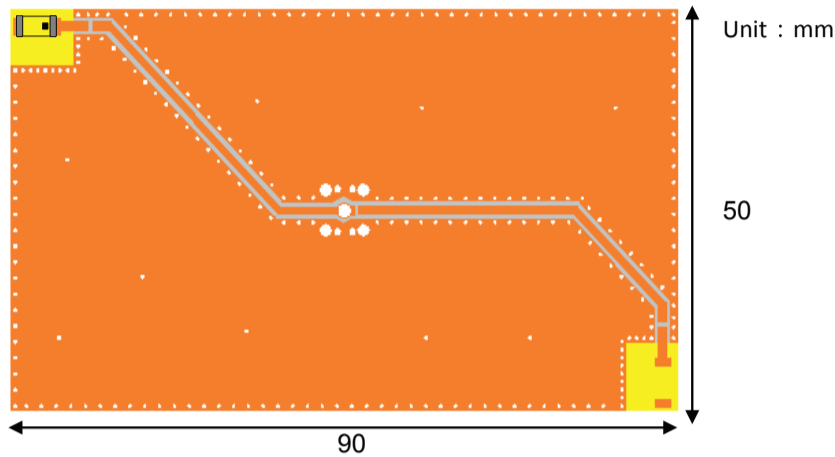

## ANTENNA RESPONSE – SMITH CHART AND RETURN LOSS S11

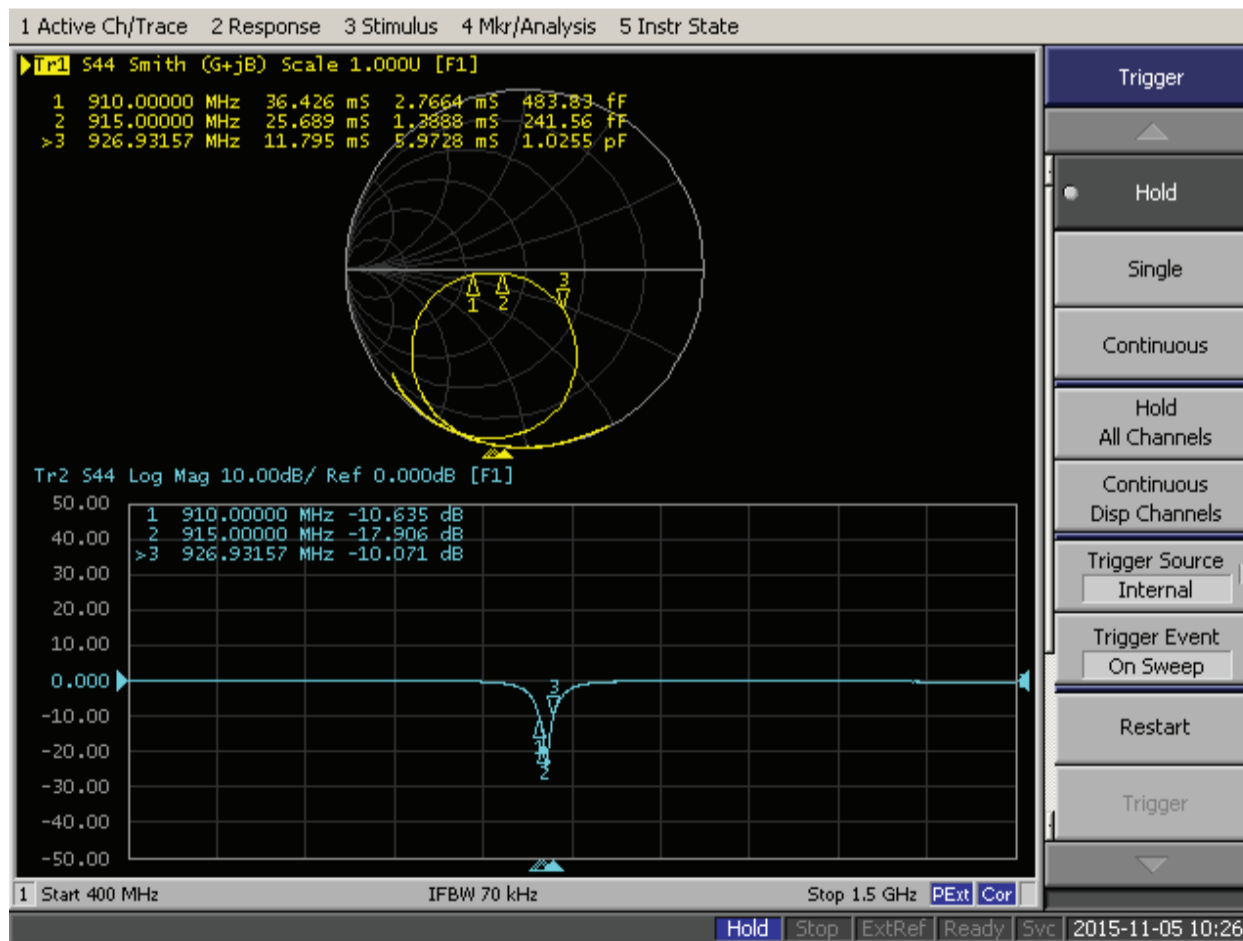

# 915 MHz Ceramic Chip Antenna

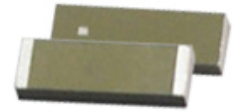

ACAG1204-915-T

12.0 x 4.0 x 1.6mm  
RoHS/RoHS II Compliant  
MSL = 1

## RADIATION PATTERNS

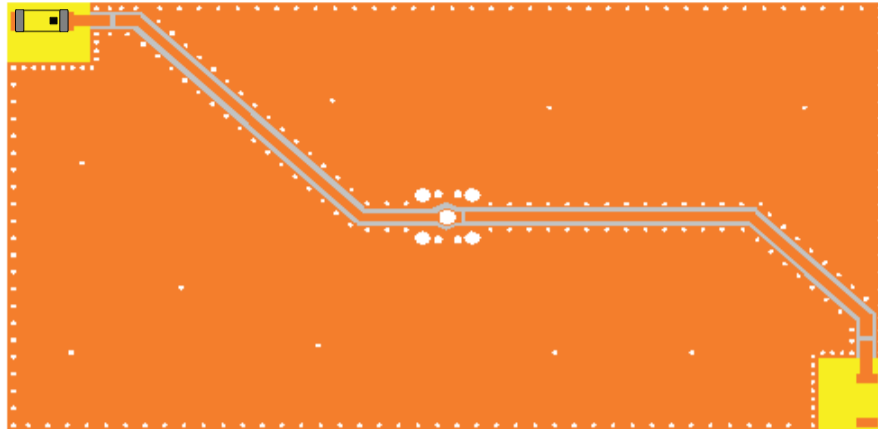
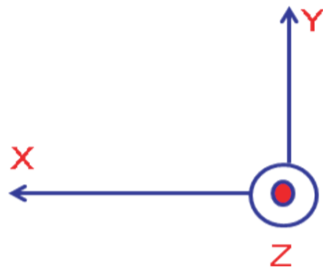

X-Z Plane

Y-Z Plane

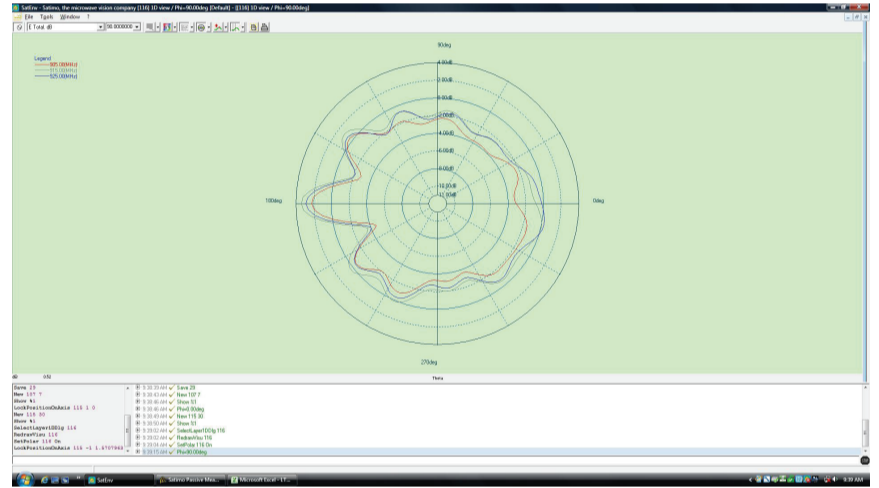
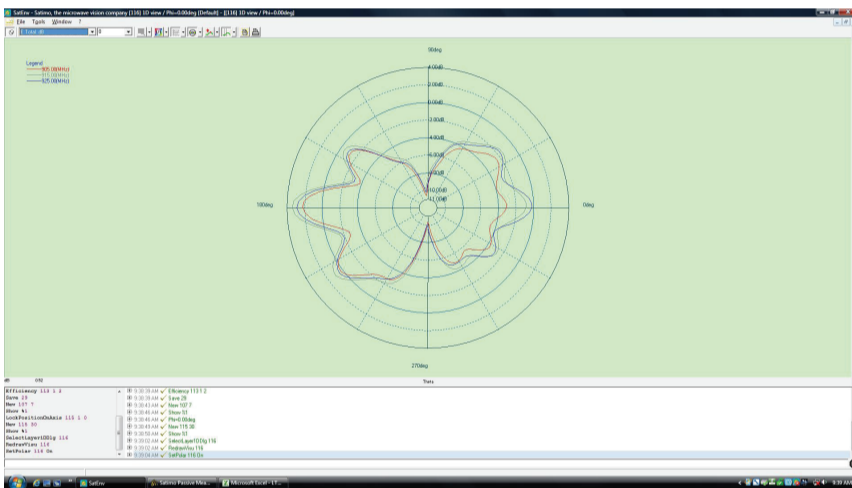

X-Y Plane

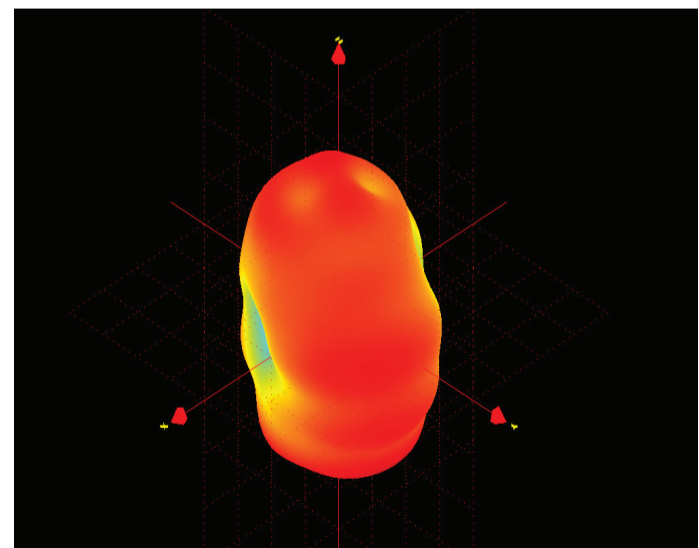
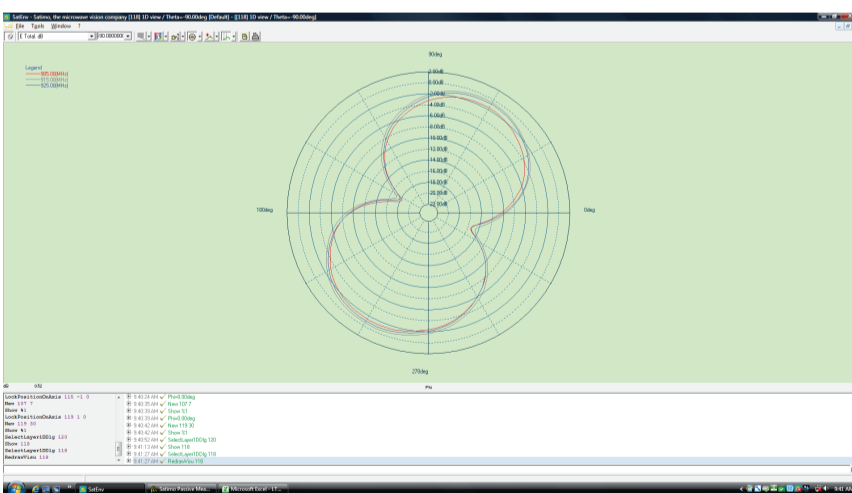

Frequency (MHz)	910	915	925
Avg. Gain (dBi)	-2.56	-2.12	-2.25
Peak Gain (dBi)	3.15	3.42	3.08
Efficiency (%)	54	59	53

# 915 MHz Ceramic Chip Antenna

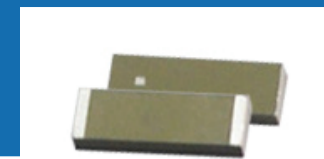

ACAG1204-915-T

12.0 x 4.0 x 1.6mm  
RoHS/RoHS II Compliant  
MSL = 1

## REFLOW PROFILE

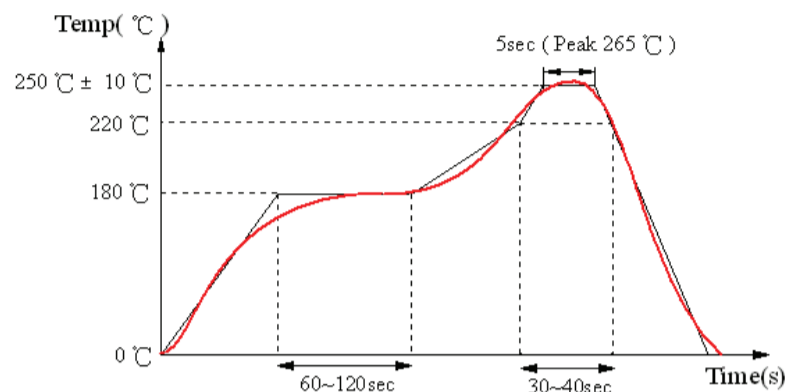

## PACKAGING

Package Type	Quantity/Size
Inner Box	3000 pcs/reel
Carton	15000 pcs/carton
Size of the carton	345 x 250 x 360 mm

Tape Dimensions (mm)

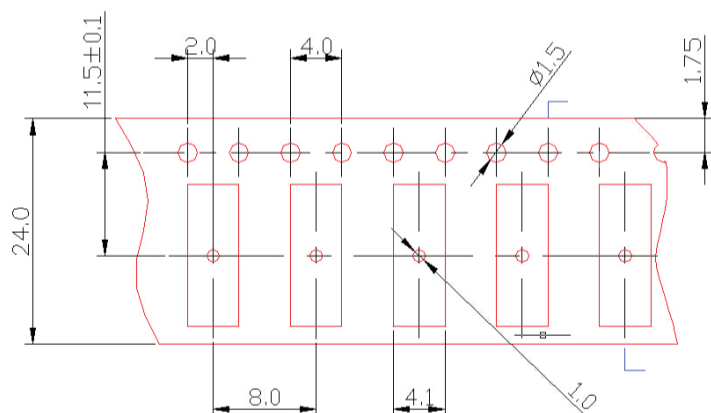

Reel Dimensions (mm)

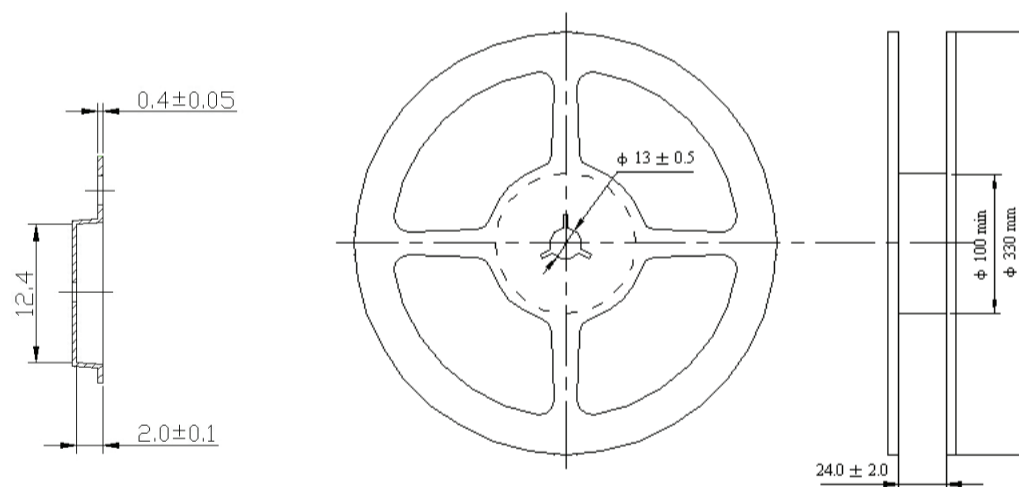

Unit: mm

## CAUTIONS

### 1. Static voltage

Static voltage between signal & ground may cause deterioration & destruction of the component. Please avoid static voltage.

### 2. Ultrasonic cleaning

Ultrasonic vibration may cause deterioration & destruction of the component. Please avoid ultrasonic cleaning.

### 3. Soldering

Only leads of the component may be soldered. Please avoid soldering to any other part of the component, such as on the patterns as this will change the performance of the antenna.